

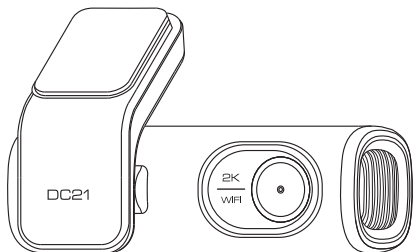

# Owner's Manual

DC21



# CONTENTS

<b>IMPORTANT SAFETY INFORMATION</b> .....	01
<b>WARRANTY AND SUPPORT</b> .....	03
<b>PACKING LIST</b> .....	04
<b>SPECIFICATION</b> .....	05
<b>GETTING STARTED</b> .....	06
Camera Overview .....	07
Installation .....	09
Calibrate Date/Time .....	11
Format Micro-SD Card .....	14
<b>GENERAL SETTING</b> .....	14
Photo Size .....	14
Video Resolution .....	14
Loop Record .....	14
Audio Recording .....	15
G-Sensor .....	15
Picture .....	15
Parking Monitor .....	15
Date/Time Format .....	16
Volume .....	16
Boot Sound .....	16
Frequency .....	16
Video Stamps .....	16
Date/Time .....	16
Free Space .....	16
Format SD Card .....	16
WDR .....	17
WiFi Name and Password .....	17
Default Settings .....	17

<b>PLAYING AND MANAGING VIDEOS</b> .....	18
Managing videos in WiFi .....	18
Managing videos by Micro-SD card reader .....	19
<b>VOICE PROMPTS</b> .....	21
<b>FAQ</b> .....	23
<b>NOTICE</b> .....	24

## ■ IMPORTANT SAFETY INFORMATION

Thank you for purchasing this OMBAR dashcam.

This instruction manual contains information on how to operate your dashcam.

Before using your dashcam, we recommend that you read through this manual to ensure correct usage.

To improve the performance of the product, the contents of this manual are subject to change without prior notice.

- **Do not disassemble, repair, or modify the product yourself.**

Doing so may cause fire, electric shock, or malfunction. For internal inspection and repair, contact the service center.

- **If any foreign matter gets inside the product, detach the power cord immediately.**

Contact the service center for repair.

- **Do not adjust the product while driving.**

Doing so may cause an accident. Stop or park your car in a safe place before installing and setting up the product.

- **Do not install the product in a location where the product can interfere with the driver's field of vision.**

Doing so may cause an accident.

- **Do not use a damaged or modified power cord. Only use the cords provided by the manufacturer.**

Damaged or modified power cords may cause an explosion, fire, or malfunction.

- **Do not operate the product with wet hands.**

Doing so may cause electric shock.

- **Do not install the product in an environment with high humidity, or combustible gases or liquids.**

Doing so may cause an explosion and/or fire.

- **Do not leave the product near infants, children, or pets.**

There is a risk of them swallowing small components, and/or their saliva may get into the product, causing an explosion due to a short circuit.

- **Do not spray water or wax directly onto the product while cleaning the inside of the car.**

Doing so may cause fire, electric shock, or malfunction.

- **If smoke or an unusual smell is emitted from the power cord, detach the power cord immediately.**

Contact the service center or your distributor.

- **Keep the terminals of the power cord clean.**

Failure to do so may cause excessive heat and fire.

- **Use the correct input voltage.**

Failure to do so may cause explosion, fire, or malfunction.

- **Plug in the power cord firmly so that it cannot easily be disconnected.**

Failure to do so may cause fire.

- **Do not cover the product with any material.**

Doing so may cause external deformation of the product or fire. Use the product and peripherals in a well-ventilated location.

## ■ WARRANTY AND SUPPORT







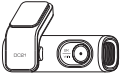

The dash cam comes with a full 12 months warranty.

If you have any questions regarding your product, please do not hesitate to contact us via Amazon or drop us an email at [support@ombars.com](mailto:support@ombars.com). Queries are typically answered within 24 working hours.

Dash cam is firmly committed to always improving our products, services, and user experience. If you have any thoughts on how we can do even better, we welcome your constructive feedback and suggestions.

## ■ PACKING LIST

Check the box for each of the following items before installing the dash cam.

 <p>Dash Cam</p>	 <p>Cigarette Lighter Power Cable (3.5m/11.6ft)</p>	
 <p>Cable Clips x 5</p>	 <p>Micro SD Card x 1</p>	 <p>Pry Tool x 1</p>
 <p>Electrostatic Sticker x 2</p>	 <p>Double-Sided Tape for the Mounting x 1</p>	 <p>User Manual x 1</p>

### Note

To improve the performance of the product, the contents of this manual are subject to change without prior notice.

## ■ SPECIFICATION

Model	DC21
Aperture	F=1.8
Color	Black
Memory	32GB SD Card
Photo Resolution	4M/3M/2M (Depends on the set video resolution)
Video Code	H.264
Photo Format	JPG
Video Compression Mode	MP4
Video Resolution	-2560x1440P -2304x1296P -1920x1080P
WiFi	Built-in(2.4GHz)
USB Port	Charging
Power Interface	5V= 2.5A
Operation Temperature	-20°C to 70°C
Storage Temperature	-30°C~ +85°C



## ■ GETTING STARTED





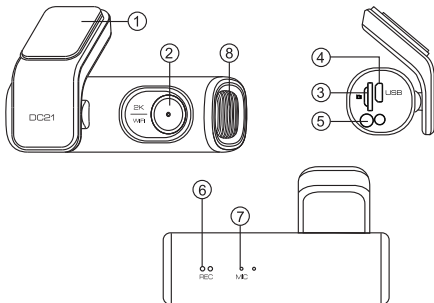

**Tips Please read and understand tips before operating.**

- **Setting Date & Time:** Please calibrate the date/time based on your location under the Date/Time by going to APP system settings menu, please refer to page 11
- **Before first time use, you MUST format the memory card in the camera to prevent any errors and for smooth operation, please refer to page 14**
- **Make sure to always keep the camera plugged into power, because camera's adapts super capacitor, if no power supply dash cam can't power on.**
- **You will need to insert a Micro-SD card before you can start recording. Please insert the SD card we provide together with our dash cam by 32GB.**

## ● Camera Overview



	Description
1	Sticker Mount
2	Lens
3	Micro-SD Card Slot
4	Micro USB Charging Port
5	WiFi Key -During recording,shortly press 1 (one) time to lock the video -Press and hold 3(three) seconds to turn ON/OFF WiFi -Press and hold 8(eight) seconds to RESET
6	Recording LED Indicator
7	Mic-Phone
8	Speaker

LED	Color	Status
⑤ WiFi		WiFi ON
		WiFi OFF
⑥ REC	 Blinking	Recording
	 Solid	Connecting to Power
	 Blinking Rapidly	Updating Firmware

## ● Installation

Install the front camera behind the rear view mirror. Remove any foreign matter and clean and dry the windshield before installation.

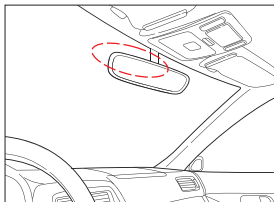

1. Turn off the engine, gently push the card into the slot until it locks into place. (We already finish the setting up with 32GB SD card)
2. Find a suitable place on windshield where don't obstruct the driver's field of vision and remove any foreign matter and clean and dry the windshield before installation. Tear off the protective layer of the electrostatic sticker and adhere the electrostatic sticker to the windshield to prevent mark/glue on your windshield after removing it.
3. Peel off the protective film from the double-sided tape and attach the front camera to the electrostatic sticker. Adjust the angle of the lens by rotating the body of the front camera.
4. Plug the cigarette lighter power cable into the cigarette lighter socket and the front camera. Use the pry tool to lift the edges of the windshield trim/molding and tuck in the power cord.

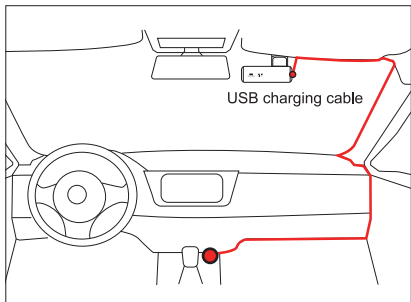

5. Turn on the engine. The dashcam will power up and start recording. Video files are stored on the microSD card. Turn off the engine. The dashcam will automatically stop recording and power down.

## ● Calibrate Date/Time

DC21 is built in WiFi, need to set Timezone first in APP so that the video date/time stamp will be correct.



1 Search for the Kacam app in the Google Play Store or Apple App Store and install it on your smartphone.

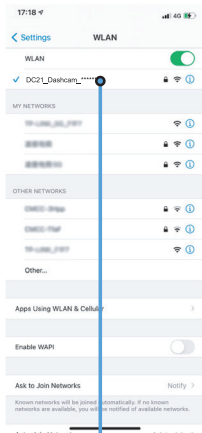

**2** Go to your smartphone's Settings to turn on WiFi, then select WiFi default named "DC21\_Dashcam\_\*\*\*\*\*" (6 randomly digital number is setting by our system), password is 12345678.

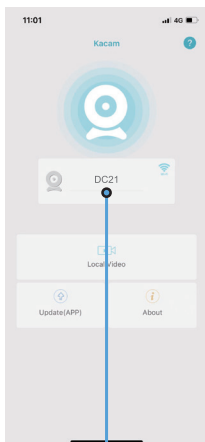

**3** There will show dash cam model DC21 when connected successfully, Check Real-time Video.

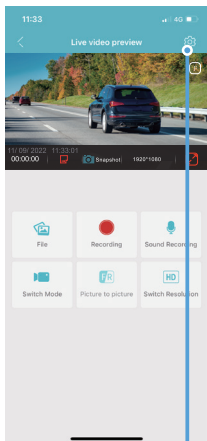

**4** Stop recording, and press the  to enter into system setting menu.

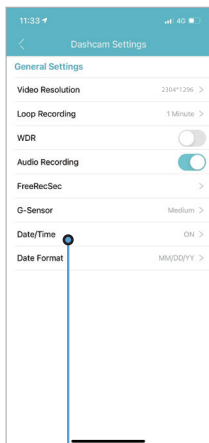

**5** Select the "Date/Time". The dash camera will automatically synchronize to your mobile phone when connected to the APP.





## Note

- WiFi Direct lets you directly connect your smartphone to your dashcam via Wi-Fi.
- The App is available for devices running Android 7.0 and higher, or iOS 9.0 and higher.

### • **Format Micro-SD Card**

Please connect to Kacam APP, using the function menu named "Format" to do.

## ■ GENERAL SETTING

### • **Photo Size — 4M/3M/2M**

Here you can choose your desired photo resolution. Higher the

resolution better the pixel resolution for captured image.

Photo resolution depends on the set video resolution.

### • **Video Resolution**

Allow to choose the desired video resolution and fps (frames per second). Higher resolution and fps videos result in smoother.

-2560x1440P

-2304x1296P

-1920x1080P

### • **Loop Record — 1min(Default)/2mins/3mins**

Allow the dash-cam to continuously record. Please notice: the dash-cam will keep deleting the oldest files automatically when memory card gets full so that it can keep recording over and over. Here select the length of video file for the loop recording.

## ● **Audio Recording — On(Default)/Off**

Dash cam has built-in microphone to record audio with video. You can choose to record mute video by choosing OFF.

## ● **G-Sensor — Off/High/Medium(Default)/Low**

G-Sensor is a 3-axis impact gravitational accelerometer which is designed to detect physical and gravitational forces on the camera.

While Video is Being Recorded: In the event when G-Sensor is triggered due to physical or gravitational impact force on the camera, the current loop cycle length of video file will be locked so it will NOT be deleted by loop cycle function.

## ● **Picture**

Show the front camera image

## ● **Parking Monitor**

This function menu will be shown when connected to 3-lead hard-wire kit (this kit is not included with our product).

— Off: The dash cam will also power off when the car power off.

— Time-Lapse Parking Mode: The function is Time-lapse Parking Monitor (1 frame per second). if set ON, When you turn OFF the car's engine and turn the key to the lock position. Then the camera will STOP the loop recording and it will go into the time-lapse parking monitor recording mode automatically.

While this time-lapse parking monitor is being recorded, If someone hits your car, then the camera will lock the time-lapse parking monitor recording files, then saved in EMR folder of micro SD card > then go on time-lapse parking monitor recording.

Now when you start your car for the next time, it will go into normal video mode automatically to start the continuous video recording.

— Impact Detection Parking Mode: If set ON, when you turn OFF the car's engine and turn the key to the lock position, the dashcam will also power off, but if someone hits your car, the dash cam will turn on to recording for 1minute and saved in EMG folder of micro SD card, then dash cam power off.

- **Date/Time Format**

This feature allows you to select the date format.

- **Volume — Low/Medium(Default)/High/Off**

This feature allows you to set the volume level for the boot sound volume, prompt volume through camera's internal built-in speaker.

- **Boot Sound**

This feature allows you to turn ON/OFF camera button's beep sound.

- **Frequency — 50HZ/60HZ(Default)**

Here you should choose the frequency accordingly to your power supply specification used in your country based on your geographical location.

- **Video Stamps**

This feature menu allows you to choose your choice of stamps for the bottom of the video. By default they are also ON.

- **Date/Time**

It will Synchronize the phone system date/time.

- **Free Space**

Free space in the Micro-SD card.

- **Format SD Card**

This feature will allow you to format inserted memory card, all the data will be deleted.

### ● **WDR-On (Default)/Off**

Wide Dynamic Range (WDR) improves the exposure by taking the combinations of over exposed and under exposed image into one robust wide range of lighting with higher depth image.

### ● **WiFi Name and Password**

WiFi SSID: DC21\_Dashcam\_\*\*\*\*\*

(\*\*\*\*\*is randomly digital number)

WiFi Password: 12345678

DC21 is built-in 2.4G WiFi module.

Note:

The WiFi name and password cannot be changed.

### ● **Default Settings**

Here you can restore all the settings to factory default settings.

## ■ PLAYING AND MANAGING VIDEOS

### ● Managing Videos in WiFi

1. Search for the Kacam app in the Google Play Store or Apple App Store and install it on your smartphone.
2. "Pair" your smartphone with the dash cam via Wi-Fi Direct:
  - a. Power on the engineer the dash cam will power on and WiFi will ON automatically. Choose your dashcam from the phone WiFi network list. The dashcam's default SSID begins with its model number (e.g.DC21\_Dashcam\_\*\*\*\*\*, password 12345678).
  - b. Go to dash cam preview interface. Press the "File" to get Photo, Video, Emergency files.
  - c. You also can select files to download into your smartphone, please find these downloaded files in APP original interface menu named "Local Video".
  - d. You can playback the video or edit the video files.

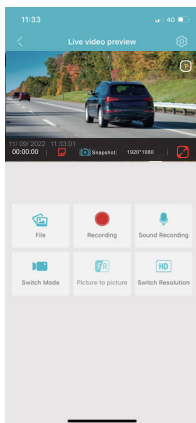
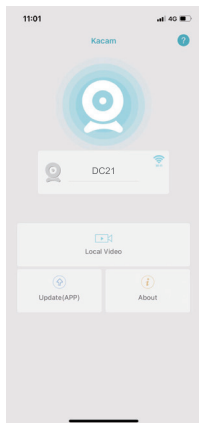

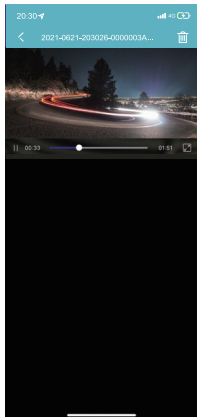

## ● Managing Videos by Micro-SD Card Reader

1. Please remove the micro SD card from camera and insert it directly in your laptop if you have a micro SD card slot (otherwise please using a micro SD card reader).
2. You should be able to see drive DASHCAM. Once you find the added flash drive, double click in it, then you will see the file folders-Movie/EMR/Photo

Movie: The loop recording video files that can be overwritten.

EMR: The video file will be locked so it will NOT be deleted by loop recording function.

Photo: The photos Then simply double click on the video to play them.

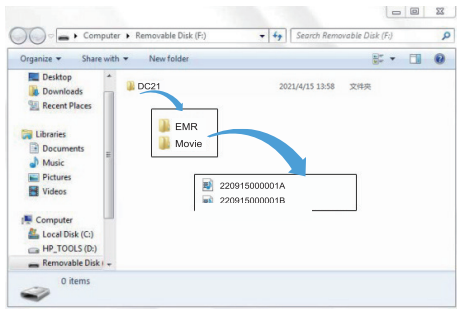

File named \*\*\*\*\*A=Front dash cam video file

## ■ VOICE PROMPTS

Voice	Description
WiFi is On	Default ON, after powered on, say it
WiFi is Off	Press and hold Wi-Fi button for 3s to switch off, say it
Recording Started	After powered on and boot ringtone /operate via App, say it
Recording Stopped	Operate via App, say it
Emergency Video	During recording once G-Sensor triggered/shortly press Wi-Fi button one (1) time to lock current video, say it
Audio Off	Default ON, operate via App, say it
Audio On	Operate via App, say it
Format Successful	Operate via App, say it
Format Failed, Please Try Again	Formatting unsuccessful, say it
WiFi is Connected	After connected to App, say it
WiFi is Disconnected	Quit out App, say it
Please Insert TF Card	If no card inserted, say it every 30s



Memory Card Error	Wrong/bad/fake memory card or memory card error, say it
Sound as "Click"	Take picture(s) via App, say it
Firmware is Updating, Please DO NOT Turn Off the Camera	FW updating starts and in progress, say it
The Locked Files are Full, Please Format TF Card	When locked files reach a certain proportion, say it
Parking Mode is On	Set Parking Mode on via App (prerequisite: connected hardwire kit), say it
Parking Mode is Off	Set Parking Mode off via App (prerequisite: connected hardwire kit), say it

## ■ FAQ

Q: I can't get live video on Kacam APP, what should I do?

If can't get live-video on APP, please turn off cellular data of Kacam APP, take iPhone and Google phone(Android 12) for example. Technical Service: support@ombars.com

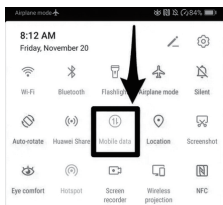
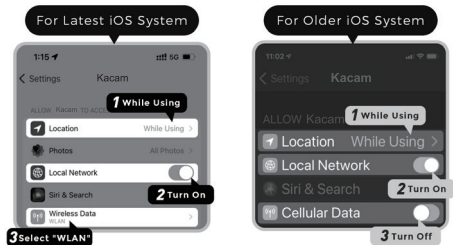

## ■ NOTICE

 This product complies with the radio interface requirements of the European Community.

 This symbol means the product must not be discarded as household waste, and should be delivered to an appropriate recycling facility. Recycling helps protect natural resources, human health and the environment. For more information on disposal and recycling of this product, contact your local municipality, disposal service, or the shop where you bought this product.

 Changes or modifications not expressly approved by the party responsible for compliance could void the user's authority to operate the equipment.

This equipment has been tested and found to comply with the limits for a class B digital device, pursuant to Part 15 of the FCC rules. These limits are designed to provide reasonable protection against harmful interference in a residential installation. This equipment generates, uses and can radiate radio frequency energy and, if not installed and used in accordance with the instructions, may cause harmful interference to radio communications. However, there is no guarantee that interference will not occur in a particular installation.

If this equipment does cause harmful interference to radio or television reception, which can be determined by turning the equipment off and on, the user is encouraged to try to correct the interference by one or more of the following measures:

- Reorient or relocate the receiving antenna.
- Increase the separation between the equipment and receiver.
- Connect the equipment into an outlet on a circuit different

from that to which the receiver is connected.

-- Consult the dealer or an experienced radio/TV technician for help.

This device complies with Part 15 of the FCC rules.

Operation is subject to the following two conditions:

(1) this device may not cause harmful interference, and (2) this device must accept any interference received, including interference that may cause undesired operation.

This equipment complies with FCC radiation exposure limits set forth for an uncontrolled environment. This equipment should be installed and operated with a minimum distance of 20cm between the radiator & your body. This transmitter must not be co-located or operating in conjunction with any other antenna or transmitter.

Product: Car Dashcam

Model: DC21

Product Warranty: One-year Limited Warranty

Customer Support: [support@ombars.com](mailto:support@ombars.com)

**C** **E** **UK** **CA** **IC** **FC** **RoHS**     
Made in China 